



25D RLF 3516



Degree: 25° ±3

Used LED

Power LED 5x5 mm



IES Renders

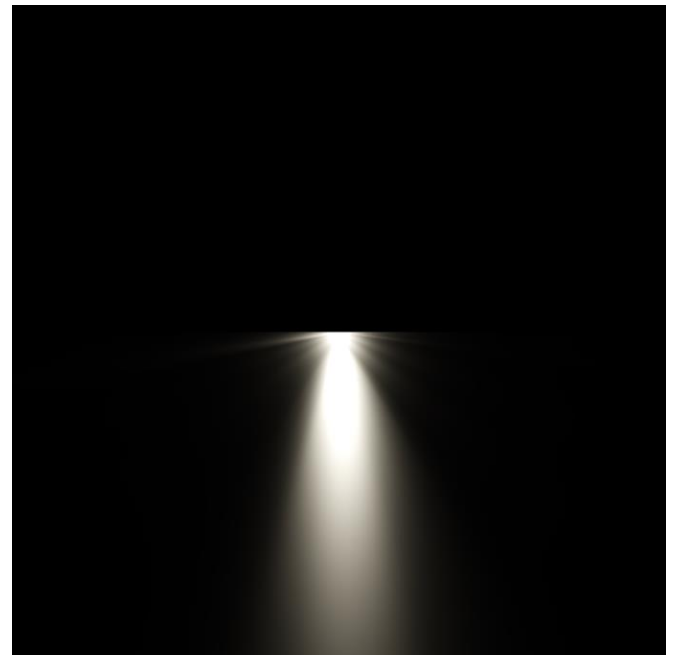
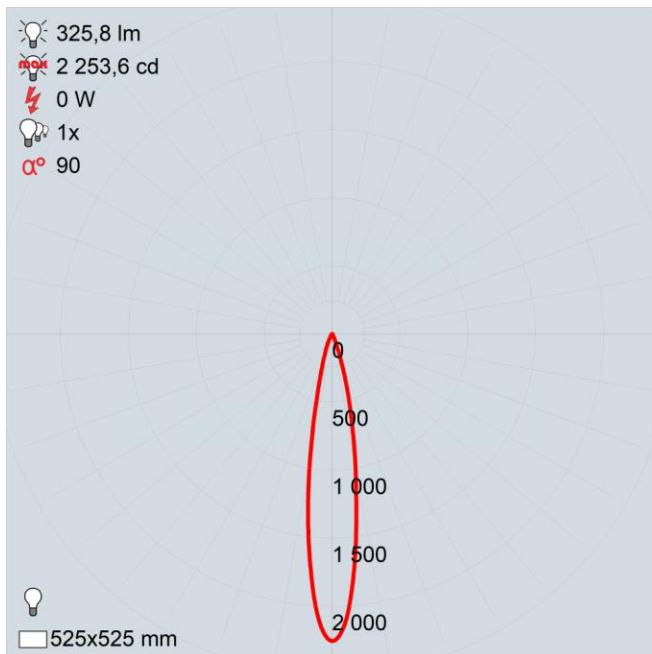



Lens Measurements

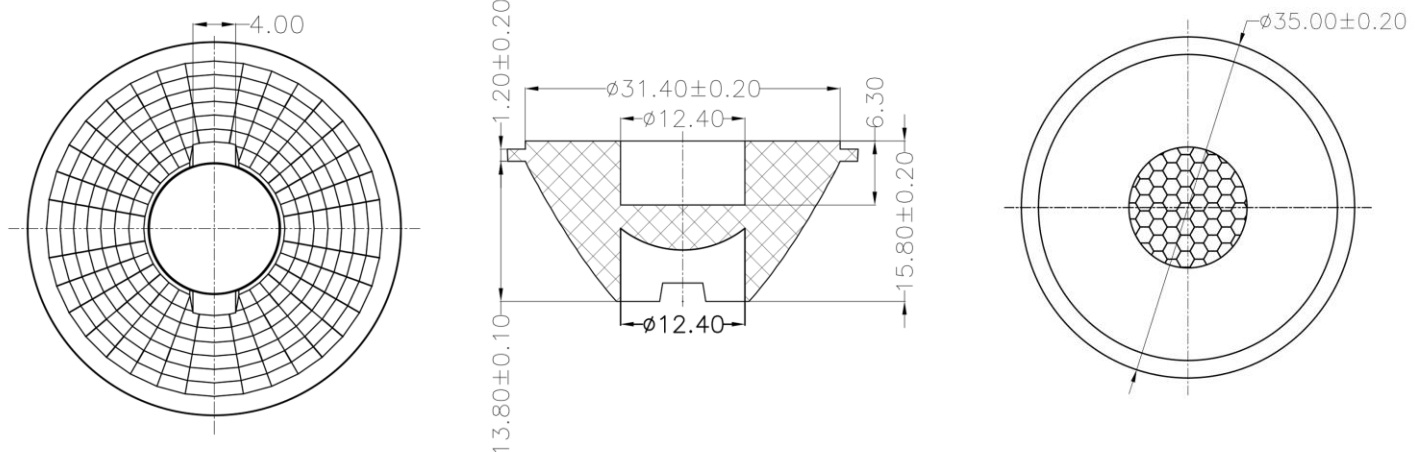

Packing Information

Box Quantity: 24 PCS
 Box Size: cm
 Box Total Kg 3%: KG

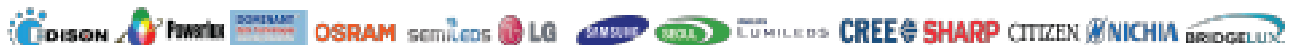

Attention & General Information

TURLENS Custom Optical Design & Manufacture (Lens for LED's). All technical data contained in this document are properties of "TURLENS". vmay subject to change the content without prior notice.

*Lens Use: Streets, Offices, Homes, Stages, Architectural, DownLight, Decorative Lighting.

Lens Material Optical Grade PMMA/PC. Best Available Optical Efficiency & Light Transmittance High.
 Operating Temperature: $-40^{\circ}\text{C} \sim +80^{\circ}\text{C}$ (upper limit $+80^{\circ}\text{C}$) PMMA UV Resistant.
 Operating Temperature: $-40^{\circ}\text{C} \sim +90^{\circ}\text{C}$ (upper limit $+90^{\circ}\text{C}$) PC with UV & V2
 Average transmittance in visible spectrum: $400\text{nm} \sim 700\text{nm} > 90\%$ - (3mm thick PMMA)
 *Holder information Operating Temperature: $-40^{\circ}\text{C} \sim +90^{\circ}\text{C}$ PC R O H S, UV & Flammability Standart V2.

Assembly info.

- *If adhesive is used, make sure that the adhesive is acid-free.
- *If you need to clean the lenses, use only mild soap and water.
 - *Use very soft cloth to dry.
 - *Do not use any solvent on lenses.
- *Our product is guarenteed against manufacturing defects only.
 - *Do not store the product in a dusty & corrosive environment.
 - *Do not touch the optical portion of the lens with your bare hands.